

# HYMAX<sup>®</sup>

Repair the past. Connect the future.

## Wide-Range Coupling Solutions



### HYMAX. CONNECTING THE FUTURE.

A revolutionary product that set a new industry standard, the HYMAX\* product line has been field-proven in millions of installations world-wide.

HYMAX Coupling solutions feature advanced engineering and innovative design, enabling fast installation, outstanding flexibility, and extreme durability in varied conditions. These benefits make the HYMAX Couplings the high-performance, cost-effective choice for a broad variety of applications.



\* This product is protected under a registered patent. See Krausz website for details.



JOIN



REPAIR



RESTRAIN

 **KRAUSZ** is the creator of HYMAX

# THE HYMAX®

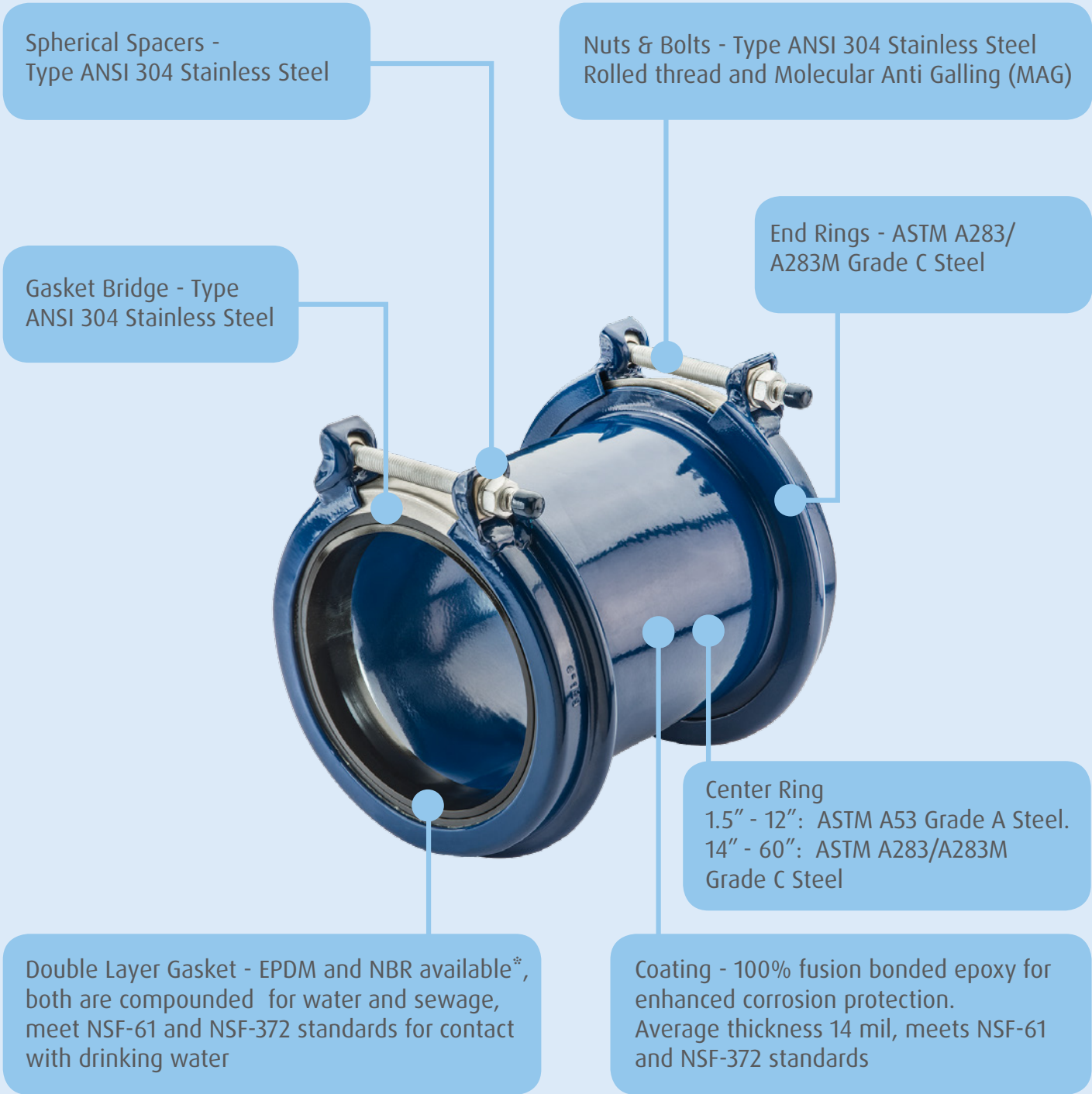

Picture is based on HYMAX 1.5"-12" - features may vary between different product sizes.

\*NBR gasket currently available for HYMAX Coupling, HYMAX Reducer, HYMAX Flange Adaptor and HYMAX Flange Adaptor Long Body.

# FAMILY

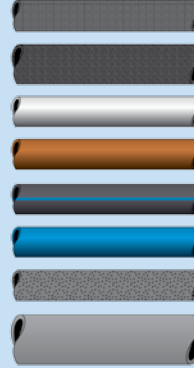

- Ductile Iron
- Cast Iron
- Steel
- Copper
- PE
- PVC
- Asbestos Cement
- GRP





# HYMAX<sup>®</sup> PRODUCT

## HYMAX WIDE RANGE COUPLING

Wide-range HYMAX Coupling, used for section replacement, connects two pipes of the same or different OD pipe diameters and materials, up to 2.1" range.



Nominal Pipe Size  
1.5" - 60"  
(26" - 60" - Made to Order)

Krausz Part Number	ND (inch)	Overall Range (inch)	Before Removing the Inner Layer (inch)	After Removing the Inner Layer (inch)	Working Pressure (PSI)	Rated Pressure (PSI)
860-56-0041-16	1.5	1.61 - 2.13	1.61 - 1.97	1.96 - 2.13	260	390
860-XX-0054-16	2	2.10 - 3.03	2.10 - 2.60	2.56 - 3.03	260	390
860-XX-0088-16	3	3.46 - 4.33	3.46 - 3.90	3.86 - 4.33	260	390
860-56-0108-16C 860-57-0108-16	4	4.25 - 5.63	4.25 - 5.00	4.92 - 5.63	260	390
860-XX-0130-16	5	5.12 - 6.38	5.12 - 5.75	5.71 - 6.38	260	390
860-XX-0163-16	6	6.42 - 7.68	6.42 - 7.05	7.01 - 7.68	260	390
860-XX-0190-16	7	7.48 - 8.74	7.48 - 8.11	8.07 - 8.74	260	390
860-XX-0217-16	8	8.54 - 9.84	8.54 - 9.17	9.13 - 9.84	260	390
860-XX-0272-16	10	10.70 - 12.00	10.70 - 11.37	11.33 - 12.00	260	390
860-XX-0278-16	10	10.96 - 12.26	10.96 - 11.63	11.59 - 12.26	260	390
860-XX-0315-16	12	12.40 - 13.66	12.40 - 13.03	12.99 - 13.66	260	390
860-XX-0334-16	12	13.15 - 14.41	13.15 - 13.78	13.74 - 14.41	260	390
860-56-0378-16P	14	15.00 - 17.10	15.00 - 16.10	16.02 - 17.10	260	390
860-56-0434-16P	16	17.10 - 19.20	17.10 - 18.19	18.11 - 19.20	260	390
860-56-0488-16P	18	19.20 - 21.30	19.20 - 20.29	20.21 - 21.30	232	350
860-56-0497-16P	20	19.60 - 21.70	19.60 - 20.69	20.61 - 21.70	232	350
860-56-0540-16P	20	21.25 - 23.35	21.25 - 22.35	22.27 - 23.35	232	350
860-56-0606-16P	24	23.85 - 25.95	23.85 - 24.96	24.88 - 25.95	232	350
860-56-0624-16P	24	24.60 - 26.70	24.60 - 25.67	25.59 - 26.70	232	350

\* NBR gasket available in sizes 2" - 12"

The product is offered in several different configurations.

Note that the "xx" marking in the Cat. no. should be replaced as directed:

**Part Number 860-XX**

56 -> EPDM gasket

57 -> NBR gasket

For example:

860-XX-0054-16 should be read as

860-56-0054-16 for EPDM gasket and

860-57-0054-16 for NBR gasket.

# SPECIFICATIONS

## HYMAX FLANGE ADAPTOR and FLANGE ADAPTOR LONG BODY

Wide-range HYMAX Flange Adaptor connects any flanged device, such as valves, pumps and other devices, with a variety of pipe diameters and materials, up to 2.1" range.

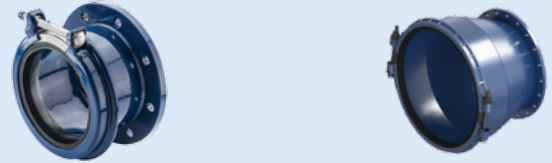

Nominal Pipe Size  
1.5" - 60"  
(26" - 60" - Made to Order)

Krausz Part Number	ND (inch)	Flange (inch)	Overall Range (inch)	Before Removing the Inner Layer (inch)	After Removing the Inner Layer (inch)	Working Pressure (PSI)	Rated Pressure (PSI)
874-56-01004112	1.5	1.5	1.61 - 2.13	1.61 - 1.97	1.96 - 2.13	175	262
874-XX-02005412	2	2	2.10 - 3.03	2.10 - 2.60	2.56 - 3.03	175	262
874-XX-03008812	3	3	3.46 - 4.33	3.46 - 3.90	3.86 - 4.33	175	262
874-XX-04010812	4	4	4.25 - 5.63	4.25 - 5.00	4.92 - 5.63	175	262
874-XX-05013012	5	5	5.12 - 6.38	5.12 - 5.75	5.71 - 6.38	175	262
874-XX-06013012	5	6	5.12 - 6.38	5.12 - 5.75	5.71 - 6.38	175	262
874-XX-06016312	6	6	6.42 - 7.68	6.42 - 7.05	7.01 - 7.68	175	262
874-XX-08019012	7	8	7.48 - 8.74	7.48 - 8.11	8.07 - 8.74	175	262
874-XX-08021712	8	8	8.54 - 9.84	8.54 - 9.17	9.13 - 9.84	175	262
874-XX-10027212	10	10	10.70 - 12.00	10.70 - 11.37	11.33 - 12.00	175	262
874-XX-10027812	10	10	10.96 - 12.26	10.96 - 11.63	11.59 - 12.26	175	262
874-XX-12031512	12	12	12.40 - 13.66	12.40 - 13.03	12.99 - 13.66	175	262
874-XX-12033412	12	12	13.15 - 14.41	13.15 - 13.78	13.74 - 14.41	175	262
874-56-14037812	14	14	15.00 - 17.10	15.00 - 16.10	16.02 - 17.10	175	262
874-56-16043412	16	16	17.10 - 19.20	17.10 - 18.19	18.11 - 19.20	175	262
874-56-18048812	18	18	19.20 - 21.30	19.20 - 20.29	20.21 - 21.30	175	262
874-56-20054012	20	20	21.25 - 23.35	21.25 - 22.35	22.27 - 23.35	175	262
874-56-24060612	24	24	23.85 - 25.95	23.85 - 24.96	24.88 - 25.95	175	262
874-56-24062412	24	24	24.60 - 26.70	24.60 - 25.67	25.59 - 26.70	175	262

\* NBR gasket available in sizes 2" - 12"

Krausz Part Number	ND (inch)	Flange (inch)	Overall Range (inch)	Before Removing the Inner Layer (inch)	After Removing the Inner Layer (inch)	Working Pressure (PSI)	Rated Pressure (PSI)
974-56-01004112	1.5	1.5	1.61 - 2.13	1.61 - 1.97	1.96 - 2.13	175	262
974-XX-02005412	2	2	2.10 - 3.03	2.10 - 2.60	2.56 - 3.03	175	262
974-XX-03008812	3	3	3.46 - 4.33	3.46 - 3.90	3.86 - 4.33	175	262
974-XX-04010812	4	4	4.25 - 5.63	4.25 - 5.00	4.92 - 5.63	175	262
974-XX-05013012	5	5	5.12 - 6.38	5.12 - 5.75	5.71 - 6.38	175	262
974-XX-06013012	5	6	5.12 - 6.38	5.12 - 5.75	5.71 - 6.38	175	262
974-XX-06016312	6	6	6.42 - 7.68	6.42 - 7.05	7.01 - 7.68	175	262
974-XX-08019012	7	8	7.48 - 8.74	7.48 - 8.11	8.07 - 8.74	175	262
974-XX-08021712	8	8	8.54 - 9.84	8.54 - 9.17	9.13 - 9.84	175	262
974-XX-10027212	10	10	10.70 - 12.00	10.70 - 11.37	11.33 - 12.00	175	262
974-XX-10027812	10	10	10.96 - 12.26	10.96 - 11.63	11.59 - 12.26	175	262
974-XX-12031512	12	12	12.40 - 13.66	12.40 - 13.03	12.99 - 13.66	175	262
974-xx-12033412	12	12	13.15 - 14.41	13.15 - 13.78	13.74 - 14.41	175	262
974-56-14037812	14	14	15.00 - 17.10	15.00 - 16.10	16.02 - 17.10	175	262
974-56-16043412	16	16	17.10 - 19.20	17.10 - 18.19	18.11 - 19.20	175	262
974-56-18048812	18	18	19.20 - 21.30	19.20 - 20.29	20.21 - 21.30	175	262
974-56-20054012	20	20	21.25 - 23.35	21.25 - 22.35	22.27 - 23.35	175	262
974-56-24060612	24	24	23.85 - 25.95	23.85 - 24.96	24.88 - 25.95	175	262
974-56-24062412	24	24	24.60 - 26.70	24.60 - 25.67	25.59 - 26.70	175	262

\* NBR gasket available in sizes 2" - 12"

## HYMAX Flange Adaptor

The product is offered in several different configurations. Note that the "xx" marking in the Cat. no. should be replaced as directed:

**Part Number 874-XX**

56 -> EPDM gasket

57 -> NBR gasket

874-XX-03008812 should be read as 874-56-03008812 for EPDM gasket and 874-57-03008812 for NBR gasket.

## HYMAX Flange Adaptor Long Body

The product is offered in several different configurations. Note that the "xx" marking in the Cat. no. should be replaced as directed:

**Part Number 974-XX**

56 -> EPDM gasket

57 -> NBR gasket

For example:

974-XX-03008812 should be read as 974-56-03008812 for EPDM gasket and 974-57-03008812 for NBR gasket.

## HYMAX LONG BODY

Wide-range HYMAX Long Body Coupling, used for pipe section replacement, connects two pipes of the same or different OD pipe and materials, covering a wider gap between the pipes, with up to up to 2.1" range.

Long couplings are typically used when there is uncertainty regarding the gap between the pipes.



Nominal Pipe Size  
1.5" - 60"  
(26" - 60" Made to Order)

Krausz Part Number	ND (inch)	Overall Range (inch)	Before Removing the Inner Layer (inch)	After Removing the Inner Layer (inch)	Working Pressure (PSI)	Rated Pressure (PSI)
862-56-0041-16	1.5	1.61 - 2.13	1.61 - 1.97	1.96 - 2.13	260	390
862-56-0054-16	2	2.10 - 3.03	2.10 - 2.60	2.56 - 3.03	260	390
862-56-0088-16	3	3.46 - 4.33	3.46 - 3.90	3.86 - 4.33	260	390
862-56-0108-16C	4	4.25 - 5.63	4.25 - 5.00	4.92 - 5.63	260	390
862-56-0130-16	5	5.12 - 6.38	5.12 - 5.75	5.71 - 6.38	260	390
862-56-0163-16	6	6.42 - 7.68	6.42 - 7.05	7.01 - 7.68	260	390
862-56-0190-16	7	7.48 - 8.74	7.48 - 8.11	8.07 - 8.74	260	390
862-56-0217-16	8	8.54 - 9.84	8.54 - 9.17	9.13 - 9.84	260	390
862-56-0272-16	10	10.70 - 12.00	10.70 - 11.37	11.33 - 12.00	260	390
862-56-0278-16	10	10.96 - 12.26	10.96 - 11.63	11.59 - 12.26	260	390
862-56-0315-16	12	12.40 - 13.66	12.40 - 13.03	12.99 - 13.66	260	390
862-56-0334-16	12	13.15 - 14.41	13.15 - 13.78	13.74 - 14.41	260	390
862-56-0378-16P	14	15.00 - 17.10	15.00 - 16.10	16.02 - 17.10	260	390
862-56-0434-16P	16	17.10 - 19.20	17.10 - 18.19	18.11 - 19.20	260	390
862-56-0488-16P	18	19.20 - 21.30	19.20 - 20.29	20.21 - 21.30	232	350
862-56-0497-16P	20	19.60 - 21.70	19.60 - 20.69	20.61 - 21.70	232	350
862-56-0540-16P	20	21.25 - 23.35	21.25 - 22.35	22.27 - 23.35	232	350
862-56-0606-16P	24	23.85 - 25.95	23.85 - 24.96	24.88 - 25.95	232	350
862-56-0624-16P	24	24.60 - 26.70	24.60 - 25.67	25.59 - 26.70	232	350

# SPECIFICATIONS

## HYMAX REDUCER

Wide-range HYMAX Reducer joins pipes different nominal sizes and materials. Each side has a tolerance of up to 2.1", joining pipes made of a variety of materials.



Nominal Pipe Size  
1.5" - 60"  
(26" - 60" Made to Order)

The product is offered in several different configurations. Note that the "xx" marking in the Cat. no. should be replaced as directed:

### Part Number 861XX

56 -> EPDM gasket

57 -> NBR gasket

861XX0054008816 should be read as

861560054008816 for EPDM gasket and

861570054008816 for NBR gasket.

Krausz Part Number	ND (inch)	Overall Range (inch)	Before Removing the Inner Layer (inch)	After Removing the Inner Layer (inch)	Overall Range 2 (inch)	Before Removing the Inner Layer 2 (inch)	After Removing the Inner Layer 2 (inch)	Working Pressure (PSI)	Rated Pressure (PSI)
861560041005416	1.5 x 2	1.61 - 2.13	1.61 - 1.97	1.96 - 2.13	2.10 - 3.03	2.10 - 2.60	2.56 - 3.03	260	390
861XX0054008816	2 x 3	2.10 - 3.03	2.10 - 2.60	2.56 - 3.03	3.46 - 4.33	3.46 - 3.90	3.86 - 4.33	260	390
861XX0088010816	3 x 4	3.46 - 4.33	3.46 - 3.90	3.86 - 4.33	4.25 - 5.63	4.25 - 5.00	4.92 - 5.63	260	390
861XX0108013016	4 x 5	4.25 - 5.63	4.25 - 5.00	4.92 - 5.63	5.12 - 6.38	5.12 - 5.75	5.71 - 6.38	260	390
861XX0108016316	4 x 6	4.25 - 5.63	4.25 - 5.00	4.92 - 5.63	6.42 - 7.68	6.42 - 7.05	7.01 - 7.68	260	390
861XX0130016316	5 x 6	5.12 - 6.38	5.12 - 5.75	5.71 - 6.38	6.42 - 7.68	6.42 - 7.05	7.01 - 7.68	260	390
861XX0163019016	6 x 7	6.42 - 7.68	6.42 - 7.05	7.01 - 7.68	7.48 - 8.74	7.48 - 8.11	8.07 - 8.74	260	390
861XX0163021716	6 x 8	6.42 - 7.68	6.42 - 7.05	7.01 - 7.68	8.54 - 9.84	8.54 - 9.17	9.13 - 9.84	260	390
861XX0190021716	7 x 8	7.48 - 8.74	7.48 - 8.11	8.07 - 8.74	8.54 - 9.84	8.54 - 9.17	9.13 - 9.84	260	390
861XX0217027216	8 x 10	8.54 - 9.84	8.54 - 9.17	9.13 - 9.84	10.70 - 12.00	10.70 - 11.37	11.33 - 12.00	260	390
861560217027816	8 x 10	8.54 - 9.84	8.54 - 9.17	9.13 - 9.84	10.96 - 12.26	10.96 - 11.63	11.59 - 12.26	260	390
861XX0217031516	8 X 12	8.54 - 9.84	8.54 - 9.17	9.13 - 9.84	12.40 - 13.66	12.40 - 13.03	12.99 - 13.66	260	390
861XX0272027816	10 X 10	10.70 - 12.00	10.70 - 11.37	11.33 - 12.00	10.96 - 12.26	10.96 - 11.63	11.59 - 12.26	260	390
861XX0272031516	10 x 12	10.70 - 12.00	10.70 - 11.37	11.33 - 12.00	12.40 - 13.66	12.40 - 13.03	12.99 - 13.66	260	390
861XX0278031516	10 x 12	10.96 - 12.26	10.96 - 11.63	11.59 - 12.26	12.40 - 13.66	12.40 - 13.03	12.99 - 13.66	260	390
861XX0278033416	10 x 12	10.96 - 12.26	10.96 - 11.63	11.59 - 12.26	13.15 - 14.41	13.15 - 13.78	13.74 - 14.41	260	390
861XX0315033416	12x 12	12.40 - 13.66	12.40 - 13.03	12.99 - 13.66	13.15 - 14.41	13.15 - 13.78	13.74 - 14.41	260	390
861560315035316	12 x 14	12.40 - 13.66	12.40 - 13.03	12.99 - 13.66	13.90 - 16.00	13.90 - 15.00	14.92 - 16.00	260	390
861560315037816	12 x 14	12.40 - 13.66	12.40 - 13.03	12.99 - 13.66	15.00 - 17.10	15.00 - 16.10	16.02 - 17.10	260	390
861560334037816	12 x 14	13.15 - 14.41	13.15 - 13.78	13.74 - 14.41	15.00 - 17.10	15.00 - 16.10	16.02 - 17.10	260	390
861560378043416	14 x 16	15.00 - 17.10	15.00 - 16.10	16.02 - 17.10	17.10 - 19.20	17.10 - 18.19	18.11 - 19.20	260	390
861560434048816	16 x 18	17.10 - 19.20	17.10 - 18.19	18.11 - 19.20	19.20 - 21.30	19.20 - 20.29	20.21 - 21.30	232	350
861560488054016	18 x 20	19.20 - 21.30	19.20 - 20.29	20.21 - 21.30	21.25 - 23.35	21.25 - 22.35	22.27 - 23.35	232	350
861560540060616	20 x 24	21.25 - 23.35	21.25 - 22.35	22.27 - 23.35	23.85 - 25.95	23.85 - 24.96	24.88 - 25.95	232	350
861560540062416	20 x 24	21.25 - 23.35	21.25 - 22.35	22.27 - 23.35	24.60 - 26.70	24.60 - 25.67	25.59 - 26.70	232	350

\* NBR gasket available in sizes 2" x 3" - 12" x 12"

# HYMAX<sup>®</sup> PRODUCT

## HYMAX THREADED OUTLET

HYMAX Threaded Outlet provides effective outlet solutions for a wide variety of piping types and diameters, joining pipes made of the same or different materials, and with varying diameters of up to 2.1".



Nominal Pipe Size  
1.5" - 60"  
(14" - 60" Made to Order)

Krausz Part Number	ND (inch)	Outlet Options (inch)	Overall Range (inch)	Before Removing the Inner Layer (inch)	After Removing the Inner Layer (inch)	Working Pressure (PSI)	Rated Pressure (PSI)
865-56-01041-16	1.5	1	1.61-2.13	1.61-1.97	1.96-2.13	260	390
865-56-XX054-16	2	1 - 1.5	2.10-3.03	2.10-2.60	2.56-3.03	260	390
865-56-XX088-16	3	1 - 2	3.46-4.33	3.46-3.90	3.86-4.33	260	390
865-56-XX108-16	4	1 - 2	4.25-5.63	4.25-5.00	4.92-5.63	260	390
865-56-XX163-16	6	1 - 4	6.42-7.68	6.42-7.05	7.01-7.68	260	390
865-56-XX217-16	8	1 - 4	8.54-9.84	8.54-9.17	9.13-9.84	260	390
865-56-XX272-16	10	1 - 4	10.70-12.00	10.70-11.37	11.33-12.00	260	390
865-56-XX278-16	10	1 - 4	10.96-12.26	10.96-11.63	11.59-12.26	260	390
865-56-XX315-16	12	1 - 4	12.40-13.66	12.40-13.03	12.99-13.66	260	390
865-56-XX334-16	12	1 - 4	13.15-14.41	13.15-13.78	13.74-14.41	260	390

For example 865-56-XX163-16 may be:

Krausz Part Number	ND (inch)	Outlet (inch)	Outlet L1 (inch)
865-56-01163-16	6	1	2.38
865-56-15163-16	6	1.5	3.12
865-56-02163-16	6	2	3.38
865-56-03163-16	6	3	4.25
865-56-04163-16	6	4	4.75



# SPECIFICATIONS

## HYMAX FLANGE OUTLET

HYMAX Flange Outlet provides effective outlet solutions for a wide variety of piping types and diameters, joining pipes made of the same or different materials, and with varying diameters of up to 2.1".



Nominal Pipe Size  
1.5" - 60" Made to Order



# HYMAX<sup>®</sup> PRODUCT

## HYMAX ELBOW

Wide-range HYMAX Elbow joins two pipes of the same or different diameters and materials, with an elbow of up to 90° angle.



Nominal Pipe Size  
2" - 24"  
(14" - 24" Made to Order)

## HYMAX 45° Elbow

Krausz Part Number	ND (inch)	Overall Range (inch)	Before Removing the Inner Layer (inch)	After Removing the Inner Layer (inch)	Working Pressure (PSI)	Rated Pressure (PSI)
869-56-45054-16	2	2.10-3.03	2.10-2.60	2.56-3.03	260	390
869-56-45088-16	3	3.46-4.33	3.46-3.90	3.86-4.33	260	390
869-56-45108-16	4	4.25-5.63	4.25-5.00	4.92-5.63	260	390
869-56-45130-16	5	5.12-6.38	5.12-5.75	5.71-6.38	260	390
869-56-45163-16	6	6.42-7.68	6.42-7.05	7.01-7.68	260	390
869-56-45190-16	7	7.48-8.74	7.48-8.11	8.07-8.74	260	390
869-56-45217-16	8	8.54-9.84	8.54-9.17	9.13-9.84	260	390
869-56-45272-16	10	10.70-12.00	10.70-11.37	11.33-12.00	260	390
869-56-45278-16	10	10.96-12.26	10.96-11.63	11.59-12.26	260	390
869-56-45315-16	12	12.40-13.66	12.40-13.03	12.99-13.66	260	390
869-56-45334-16	12	13.15-14.41	13.15-13.78	13.74-14.41	260	390

## HYMAX 90° Elbow

Krausz Part Number	ND (inch)	Overall Range (inch)	Before Removing the Inner Layer (inch)	After Removing the Inner Layer (inch)	Working Pressure (PSI)	Rated Pressure (PSI)
869-56-90054-16	2	2.10-3.03	2.10-2.60	2.56-3.03	260	390
869-56-90088-16	3	3.46-4.33	3.46-3.90	3.86-4.33	260	390
869-56-90108-16	4	4.25-5.63	4.25-5.00	4.92-5.63	260	390
869-56-90130-16	5	5.12-6.38	5.12-5.75	5.71-6.38	260	390
869-56-90163-16	6	6.42-7.68	6.42-7.05	7.01-7.68	260	390
869-56-90190-16	7	7.48-8.74	7.48-8.11	8.07-8.74	260	390
869-56-90217-16	8	8.54-9.84	8.54-9.17	9.13-9.84	260	390
869-56-90272-16	10	10.70-12.00	10.70-11.37	11.33-12.00	260	390
869-56-90278-16	10	10.96-12.26	10.96-11.63	11.59-12.26	260	390
869-56-90315-16	12	12.40-13.66	12.40-13.03	12.99-13.66	260	390
869-56-90334-16	12	13.15-14.41	13.15-13.78	13.74-14.41	260	390

# SPECIFICATIONS

## HYMAX CATHODIC

Wide-range HYMAX Coupling with cathodic anti-corrosion protection feature connects two pipes of the same or different diameters and materials.



Nominal Pipe Size  
1.5" - 24"  
(26" - 60" Made to Order)

The product is offered in several different configurations. Note that the "xx" marking in the Cat. no. should be replaced as directed:

**Part Number 888-XX**

56 -> EPDM gasket

57 -> NBR gasket

For example:

888-XX-0054-16 should be read as

888-56-0054-16 for EPDM gasket and

888-57-0054-16 for NBR gasket.

Krausz Part Number	ND (inch)	Overall Range (inch)	Before Removing the Inner Layer (inch)	After Removing the Inner Layer (inch)	Working Pressure (PSI)	Rated Pressure (PSI)
888-56-0041-16	1.5	1.61 - 2.13	1.61 - 1.97	1.96 - 2.13	260	390
888-XX-0054-16	2	2.10 - 3.03	2.10 - 2.60	2.56 - 3.03	260	390
888-XX-0088-16	3	3.46 - 4.33	3.46 - 3.90	3.86 - 4.33	260	390
888-56-0108-16C 888-57-0108-16	4	4.25 - 5.63	4.25 - 5.00	4.92 - 5.63	260	390
888-XX-0130-16	5	5.12 - 6.38	5.12 - 5.75	5.71 - 6.38	260	390
888-XX-0163-16	6	6.42 - 7.68	6.42 - 7.05	7.01 - 7.68	260	390
888-XX-0190-16	7	7.48 - 8.74	7.48 - 8.11	8.07 - 8.74	260	390
888-XX-0217-16	8	8.54 - 9.84	8.54 - 9.17	9.13 - 9.84	260	390
888-XX-0272-16	10	10.70 - 12.00	10.70 - 11.37	11.33 - 12.00	260	390
888-XX-0278-16	10	10.96 - 12.26	10.96 - 11.63	11.59 - 12.26	260	390
888-XX-0315-16	12	12.40 - 13.66	12.40 - 13.03	12.99 - 13.66	260	390
888-XX-0334-16	12	13.15 - 14.41	13.15 - 13.78	13.74 - 14.41	260	390
888-56-0378-16P	14	15.00 - 17.10	15.00 - 16.10	16.02 - 17.10	260	390
888-56-0434-16P	16	17.10 - 19.20	17.10 - 18.19	18.11 - 19.20	260	390
888-56-0488-16P	18	19.20 - 21.30	19.20 - 20.29	20.21 - 21.30	232	350
888-56-0497-16P	20	19.60 - 21.70	19.60 - 20.69	20.61 - 21.70	232	350
888-56-0540-16P	20	21.25 - 23.35	21.25 - 22.35	22.27 - 23.35	232	350
888-56-0606-16P	24	23.85 - 25.95	23.85 - 24.96	24.88 - 25.95	232	350
888-56-0624-16P	24	24.60 - 26.70	24.60 - 25.67	25.59 - 26.70	232	350

\* NBR gasket available in sizes 2" - 12"

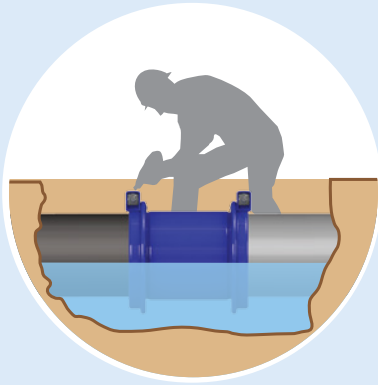

## Fast and easy installation

- Lightweight construction enables fast and easy installation, with minimum manpower, reducing time in the ditch and improving worker safety.
- Unique top-facing bolts enable easy installation access.
- Ready-to-use, stab-on design eliminates the need for extensive under-pipe digging and work.



## Multiple applications

- Broad variety of products, from couplings to flange adaptors and reducers.
- Extensive portfolio of products with 1.5" - 60" nominal pipe size.
- All products work with a variety of pipe materials: ductile iron, cast iron, steel, copper, PE, PVC, AC, and GRP.
- One single product can connect pipes of two different materials, allowing transition capability of up to 2.1".

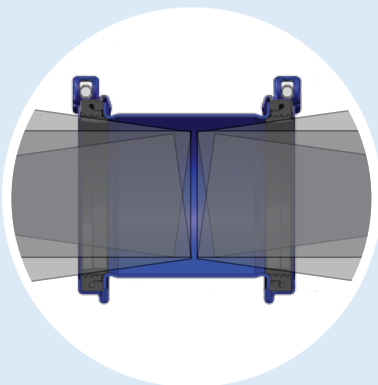

## Flexible connection

- Allows for up to 4° angular deflection on each end, as well as for misaligned pipes.
- Absorbs post-installation dynamic pipe deflection of up to 4° on each end, reducing the risk of damage and cracking due to ground shifts and temperature changes.
- Adapts to out-of-round pipe shape (up to 0.51"), for optimum fit on both ends.

# FAMILY FEATURES



## High durability

- High-quality sealing solution – patented hydraulically-assisted gasket features two-stage sealing: mechanical sealing that is effective under vacuum or non-pressure; and self-inflated gasket using water pressure.
- Fusion-bonded epoxy coating enables an insulated product and prevents corrosion.
- Nuts, bolts and other components are made of stainless steel.
- Innovative radial closing design and sealing systems eliminate installation errors.
- Advanced Molecular Anti-Galling (MAG) unique dry treatment process on nuts and bolts, based on embedded zinc, prevents galling and enables repeated bolt tightening; it also eliminates the need for grease, preventing dust and dirt build-up.
- One-piece design delivers fortified strength and enhanced flexibility.

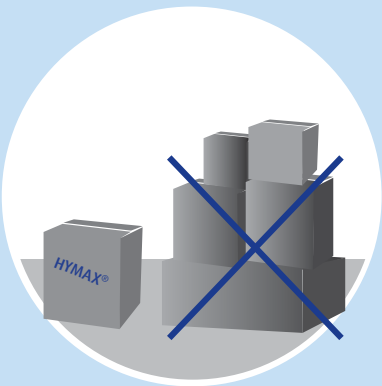

## Cost-saving

- HYMAX products suit a wide range of pipe diameters, replacing the need to use dedicated products and thus reducing inventory costs and saving shelf space.
- Fast and easy installation saves time and money.



## HYMAX® Product Information

1. HYMAX meets or exceeds all specifications of AWWA Standard C219, NSF-61 and NSF-372.
2. Center Ring:
  - 1.5" – 12": ASTM A53 Grade A Steel.
  - 14" – 60": ASTM A283/A283M Grade C Steel.
3. End ring: ASTM A283/A283M Grade C Steel.
4. Gaskets: EPDM and NBR available, both are compounded for water and sewage, meet NSF-61 and NSF-372 standards for contact with drinking water.
5. Nuts and bolts: ANSI 304 Stainless Steel. Rolled thread and Molecular Anti Galling (MAG) treatment.
6. Bridge: ANSI 304 Stainless Steel.
7. Coating: 100% fusion bonded epoxy for enhanced corrosion protection. Average thickness 14 mil, meets NSF-61 and NSF-372 standards.
8. Deflection up to 4° per side (one side only for Flange Adaptor).
9. Working temperature:
  - EPDM: -20°F up to +125°F
  - NBR: -4°F up to +125°F.

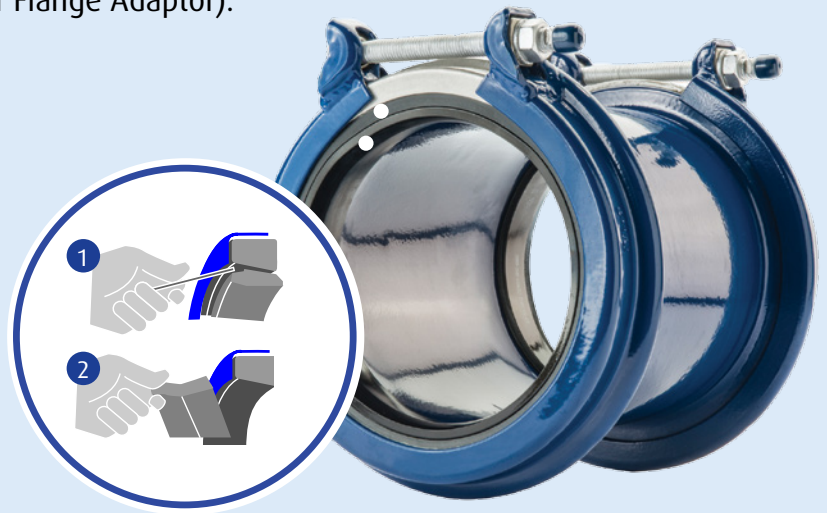

\* Data may vary according to product type and size. For product specification sheet please refer to our website: [www.krauszusa.com](http://www.krauszusa.com)

Two Layer Gasket allows adjusting to pipe diameter

# 90 YEARS OF INNOVATIVE PIPE JOIN AND REPAIR SOLUTIONS



For 90 years, Krausz, the creator of HYMAX, has developed and manufactured market-leading products for the repair and connection of different pipe types in the potable water and sewage markets.

We have a solid reputation selling a wide variety of innovative, easy-to-use, durable products that save time and reduce inventory.





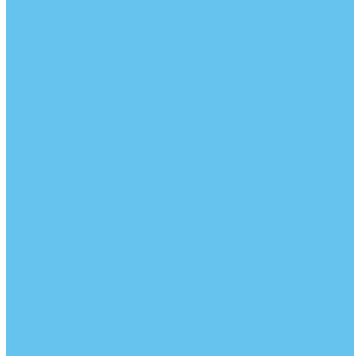

**KRAUSZ USA**  
**331 SW 57TH AVENUE, OCALA,**  
**FLORIDA 34474**  
**TEL: 855-457-2879 OR 855-4KRAUSZ**  
**FAX: 352-304-5787**

[INFO@KRAUSZUSA.COM](mailto:INFO@KRAUSZUSA.COM)  
[WWW.KRAUSZUSA.COM](http://WWW.KRAUSZUSA.COM)



**KRAUSZ** is the creator of Hymax